

 YAMAHA

# Trumpets

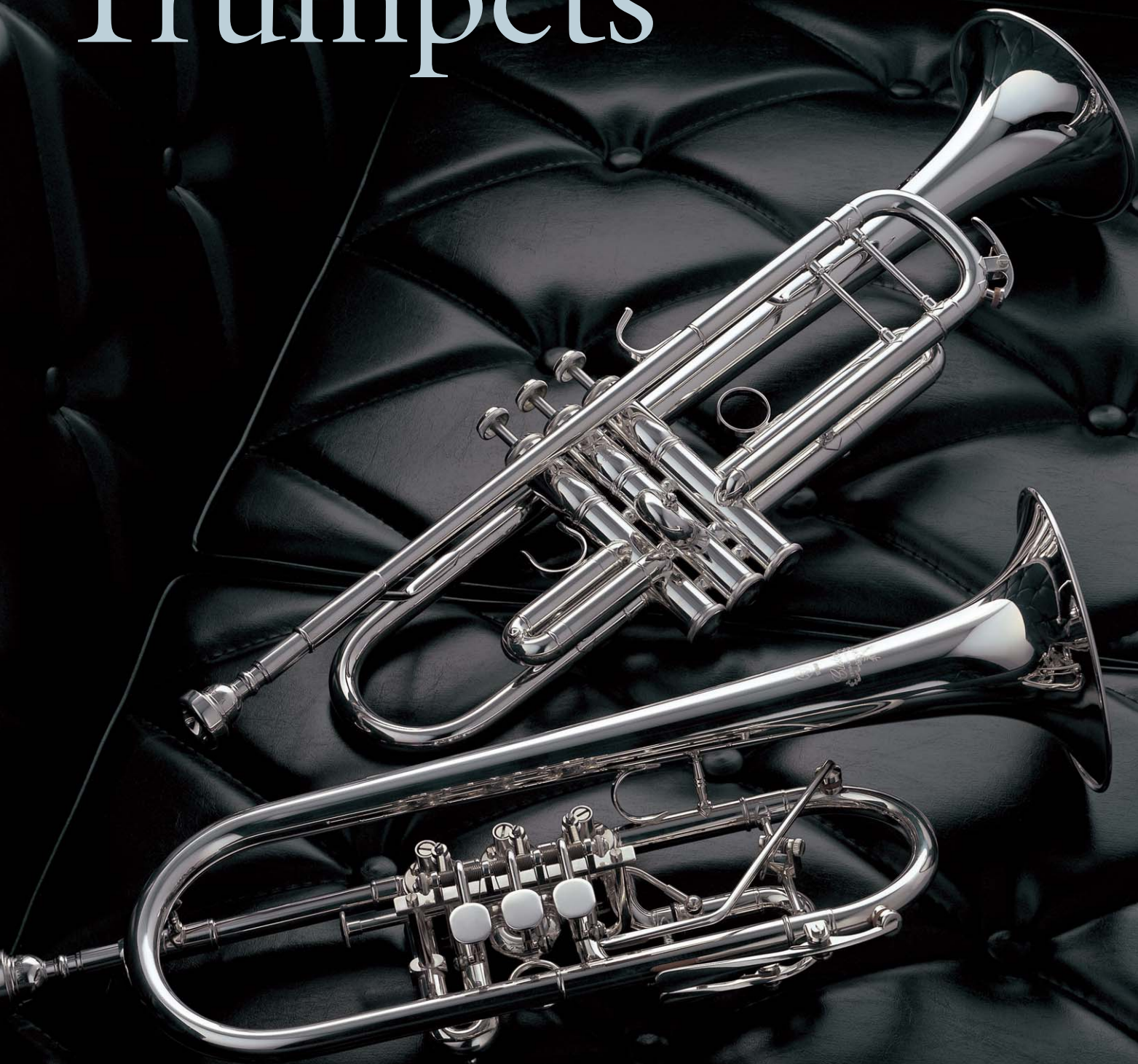



## A Lead-Free Future with Yamaha Wind Instruments

Yamaha instruments use only lead-free solder in the pursuit of musical excellence.

### **LEAD FREE SOLDER**

Yamaha wind instruments are manufactured with lead-free solder.

By the time RoHS (Restriction of Hazardous Substances directive) came into effect in July 2006, the use of lead-free solders had become common throughout the manufacturing sector. While wind instruments were exempt from the regulation, we chose to switch as well, making Yamaha the first company to bring lead-free solder to wind instruments.

Before we could use lead-free solder however, a number of issues had to be addressed, such effects on sound quality, improving technical accuracy, and developing new manufacturing procedures. After six years of in depth research and development, our objectives have been met making the instruments we manufacture deliver sound quality that is better than ever.

Lead-free solder is also being used for wind instrument maintenance in both our domestic and overseas operations.

Looking to the future, we at Yamaha will continue creating and manufacturing wind instruments with an emphasis on sound and music, mankind and the environment.



## Contents

4	Xeno Artist Model Trumpets	18	Rotary Trumpets
6	Xeno Series Trumpets	19	Flugelhorns
8	Custom Series Trumpets	20	Cornets
10	Professional Model Trumpets	22	Yamaha Trumpet Mouthpieces
11	Intermediate Model Trumpets	24	Artist Profiles & Comments
12	Student Model Trumpets	25	SILENT BRASS™
15	B $\flat$ /A Piccolo Trumpets	26	Get to Know the Basic Trumpet Parts/Other Tips for Choosing a Trumpet/Scale Range (B $\flat$ )
16	E, E $\flat$ & D Trumpets	27	Trumpets & Piccolo Trumpets Specifications
17	G/F Trumpet	28	Cornets & Flugelhorns Specifications
17	Herald Trumpet		



# Every Artist can Create a Masterpiece

Yamaha trumpets are crafted with outstanding attention to the smallest details, making them the ideal choice for every performer. Their consistency in manufacturing, flexible tonal color and excellent intonation bring out the individual artistry of each musician. At the same time, their sound blends easily with other instruments in an orchestra or band just like each brush stroke on an oil painting work together to create a beautiful masterpiece.





# Xeno Artist Model Trumpets

## Series Background

Many players spend their careers in the elusive search for the ideal trumpet. Even after tweaking their horns with custom-made lead pipes and other parts, these players struggle to find the sound they're looking for. They don't compromise in their playing, so why should they settle for less than the best in an instrument? With the Xeno, Yamaha takes up the challenge of creating a trumpet series more expressive than even the finest individually customized instruments.

## The "Chicago" Series

Modeled to the specifications of the Chicago Symphony's John Hagstrom, the Chicago Series studied a set of famous vintage trumpets owned by the orchestra. John worked with Yamaha to test parts and prototypes that would improve upon the design and legendary sound of these classic horns.

### B $\flat$ Trumpet



#### YTR-9335CHS *MalonePipe™*

Key=B $\flat$

Bell: one piece yellow brass, 123 mm (4-7/8")

Bore size: ML – 11.65 mm (0.459")

Finish: silver plate

Mouthpiece: TR17B4



YTR-9335CHS

### C Trumpet



#### YTR-9445CHS *MalonePipe™*

Key=C

Bell: one piece yellow brass, 123 mm (4-7/8")

Bore size: L – 11.73 mm (0.462")

Finish: silver plate

Mouthpiece: TR17B4



YTR-9445CHS



The Xeno's bell is one of its most vital features. The wall gradually tapers, thinning as it gets closer to the rim. A wide, flat rim helps hold sound together even at the extreme dynamic ranges. The seam of the bell is also aligned with the braces to improve tonal projection, and the braces are smaller to bring the bell, valves and lead pipe closer together, giving a natural vibrancy to the entire trumpet.



The first valve slide features a special brace that focuses the tone for unparalleled definition and clarity. (YTR-9335CHS, YTR-9445CHS)



The 3rd valve slide stopper has been moved to allow extended slide play for a low F or to facilitate alternative fingerings. The oversized button on the end of the slide has been carefully designed to fine-tune the blowing resistance for improved control. (YTR-9445CHS)



The braces between the bell, valve casing, and lead pipe are smaller to bring the parts closer together, lending a natural vibrancy to the entire trumpet.

## Development Story

Yamaha selected a development team of acclaimed trumpet artists who share the dream of creating the most expressive trumpet possible. The team has worked closely with Yamaha's research and development experts to study every aspect of the trumpet—down to the most minuscule details—in order to create a truly great product.

The Xeno Artist Model Series features behind-the-scenes work by a large crew of artisans, technicians and scientists searching for the parts and prototypes needed to consistently develop these artists' vision. With new production techniques, fine-tuning and painstaking adjustment, the Yamaha team has used unprecedented precision to create the Xeno.

## The “New York” Series

Working alongside trumpeter and educator Robert Sullivan, Yamaha created the New York Series. He began the project while performing as an assistant principal in the New York Philharmonic. The collaboration was carried out simultaneously while Yamaha developed the Chicago Series. The two project teams shared insights about tonal colors, projection and intonation, which led to the creation of a truly expressive instrument.

### B $\flat$ Trumpet



**YTR-9335NYS** *MalonePipe™*

Key=B $\flat$

Bell: one piece yellow brass, 123 mm (4-7/8")

Bore size: ML – 11.65 mm (0.459")

Finish: silver plate

Mouthpiece: TR17B4



YTR-9335NYS

### C Trumpet



**YTR-9445NYS** *MalonePipe™*

Key=C

Bell: one piece yellow brass, 123 mm (4-7/8")

Bore size: L – 11.73 mm (0.462")

Finish: silver plate

Mouthpiece: TR17B4



YTR-9445NYS



The new shape of top and bottom valve caps and the skeletonized interior valve stems contribute greatly to the flexible response of the trumpet. Specially formulated synthetic pads lend an improved touch to the valve action while preserving accurate piston alignment and adding clarity to the tone of the trumpet.

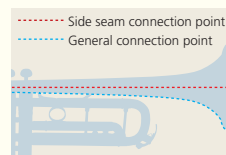

Both the Chicago series and the New York series use side seams, a method of placing the connection point on the valve casing side rather than the conventional method of putting the connection point on the lower side of the bell. This design creates a more open vibration.

*MalonePipe™*

Based on leadpipes designed by renowned brass instrument artisan Bob Malone, the *MalonePipe™* is available in several keys, offering quick response, superior intonation and unparalleled evenness of tone: Originally a trumpet player himself, Bob Malone opened his own custom brass shop in Los Angeles in 1983. Trumpeters flocked to his shop to have him personally customize their horns. His original leadpipe design has enjoyed wide acclaim and is still held in high regard among trumpet players. Since Bob joined Yamaha's Research and Development team in 2001, his *MalonePipe™* design has made its way into a number of Xeno Artist models and Custom series instruments. Rich and brilliant tone with excellent projection, the *MalonePipe™* brings total expression to your music.

# Xeno Series Trumpets

## Just What You've Been Looking For ...

Xeno (pronounced "Zeno") Trumpets are designed for those who want power and projection as well as a big warm sound. Developed from more than 30 years of research with leading musicians throughout the world, Xeno trumpets incorporate these artists' dreams, experiences and talents as realized through the skills and ideas of some of the world's best designers and craftsmen. Traditional hand-craftsmanship augmented by cutting-edge manufacturing technology has created extraordinary quality and unprecedented consistency.

The Xeno's heavyweight construction produces a solid tone core for a rich strong sound that won't spread or break up no matter how hard you push it. It blows freely and comfortably while still providing enough air resistance for quick response and superb tonal flexibility. And the hand-hammered one-piece bell gives an agile, quick response with a beautiful tone.

## B $\flat$ Trumpets

Xeno B $\flat$  Trumpets offer a choice of bore sizes: medium-large for versatility and large for a broad sound with plenty of power.

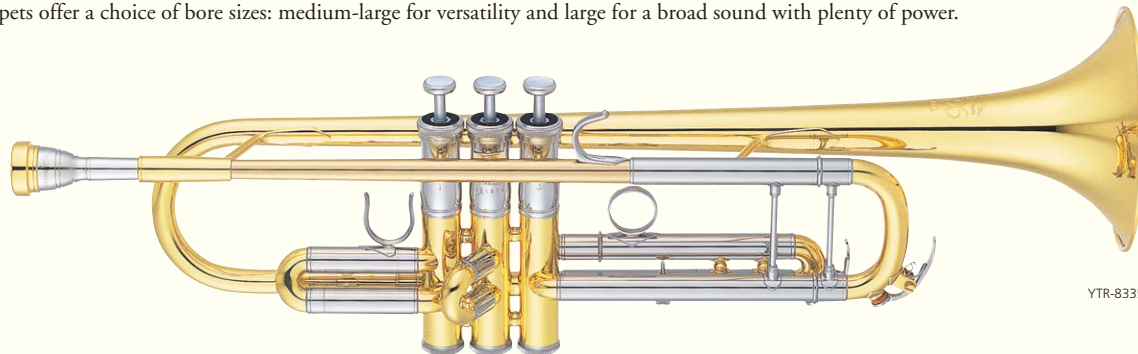

### YTR-8335

YTR-8335 is a medium-sized Xeno B $\flat$  Trumpet with versatile uses.

B $\flat$  and C Xenos have the following bell options: yellow brass for clear sound with strong projection and gold brass for a warmer, deeper sound.

Key=B $\flat$

Bell: one piece yellow brass, 123 mm (4-7/8")

Bore size: ML – 11.65 mm (0.459")

Finish: clear lacquer

Mouthpiece: TR16C4-GP

With gold brass bell: YTR-8335G

With silver plate finish: YTR-8335S/YTR-8335GS



### YTR-8345

YTR-8345 is a large-bore Xeno B $\flat$  Trumpet with a broad sound and plenty of power.

Key=B $\flat$

Bell: one piece yellow brass, 123 mm (4-7/8")

Bore size: L – 11.73 mm (0.462")

Finish: clear lacquer

Mouthpiece: TR16C4-GP

With gold brass bell: YTR-8345G

With silver plate finish: YTR-8345S/YTR-8345GS

## Reversed Leadpipe Model B $\flat$ Trumpet



YTR-8335RGS

### YTR-8335RGS

This model adopts a unique “reverse-style” design with staggered main pipe valve slides, creating a smooth response. A heavy mouthpiece receiver and daring removal of the third valve water key results in a superb balance of playability and tonal quality. With this model, musicians will be able to produce a firm sound in all dynamic ranges, from delicate pianissimo to powerful fortissimo.

Key=B $\flat$

Bell: one piece gold brass, 123 mm (4-7/8")

Bore size: ML – 11.65 mm (0.459")

Finish: silver plate

Mouthpiece: TR16C4-GP

## C Trumpets



YTR-8445S

### YTR-8445

The Xeno Series C Trumpets are ideal for use in any performance. The brilliant tonal color and accurate intonation respond to the expressive ability of the performer. The series is available in either yellow brass or gold brass (both finished in silver plating).

Key=C

Bell: one piece yellow brass, 123 mm (4-7/8")

Bore size: L – 11.73 mm (0.462")

Finish: clear lacquer

Mouthpiece: TR16C4-GP

With gold brass bell: YTR-8445G

With silver plate finish: YTR-8445S/YTR-8445GS

# Custom Series Trumpets

## Custom Models with Shining Individuality

Collaboration with the world's leading artists is essential for crafting Yamaha instruments. Yamaha tirelessly pursues the incorporation of artists' ideas or experiences to create instruments that enable musical expression at higher levels. Traditional techniques, the latest research, and collaboration of refined artists and expert craftsmen create the potential for ultimate performance.

### Wayne Bergeron with Yamaha

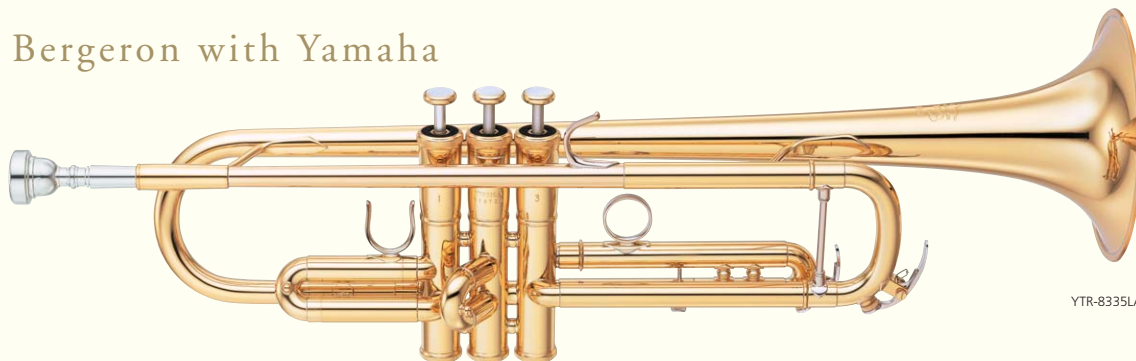

YTR-8335LA



The YTR-8335LA was developed together with Wayne Bergeron, one of the most sought-after West Coast studio players. Outstanding attention to detail including the lavish French bead and side seams in medium-large bore tubing results in superior operability with strong, brilliant tonal colors suited to various genres, particularly jazz or popular music.

#### YTR-8335LA

Key=B $\flat$   
Bell: one piece yellow brass, 127 mm (5")  
Bore size: ML – 11.65 mm (0.459")  
Finish: gold lacquer  
Mouthpiece: TR14B4

With silver plate finish: YTR-8335LAS

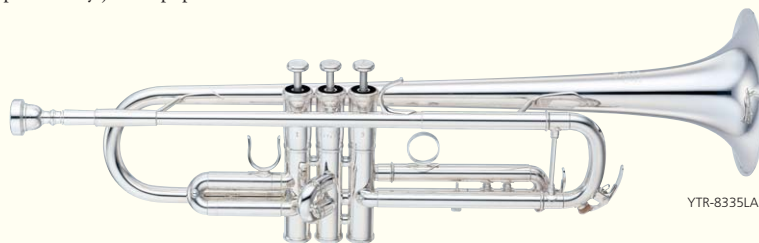

YTR-8335LAS

### Eric Miyashiro with Yamaha



YTR-8340EM



This model, developed in collaboration with Eric Miyashiro, draws out the emotional resonance of the performer. From its triple ring finger hook, large bell with French bead, side seam finish and customized mouthpiece design to its semi-hard double backpack case, the instrument showcases Yamaha's attention to detail at every turn.

#### YTR-8340EM

Key=B $\flat$   
Bell: one piece yellow brass, 134.4 mm (5-1/4")  
Bore size: multi-bore  
Finish: gold lacquer  
Mouthpiece: EM1

#### Multi-bore

When the piston is not depressed, the trumpet has the same bore structure as a B $\flat$  trumpet as M bore size. However when the piston is depressed, the unique "multibore" structure reduces the difference in back pressure by passing through the L bore valve slide.

#### French Bead

Unlike traditional methods where a round rim is used in curling, French bead is an extremely advanced technique that matches the curling to the shape of a semi-cylindrical rim and is characterized by improved feedback of sound to the performer.

#### Side Seam

Side seaming is the process of placing the connection point on the lateral valve casing side in contrast to the conventional method of placing the connection point on the lower side of the bell. Side seam trumpets are characterized by a more open vibration.



## Custom Z Bobby Shew with Yamaha

### All Trumpets Are Not Alike



The Z was born of Yamaha's long and close partnership with legendary trumpeter Bobby Shew. An incredibly versatile musician, Shew needed one efficient instrument that could scream out a powerful lead and play soft, mellow ballads. With the Z, he finally found an instrument that met all of his playing requirements.

The original YTR-6310Z was considered by many leading artists to be the best trumpet on the market, and they were skeptical when they learned that Yamaha was attempting to improve it. But trumpet designer Shunichi Niwata and research and development specialist Bob Malone worked together with Bobby again using all the special techniques learned since designing the first Z.

The handmade bell is one of the biggest Yamaha makes, and its tapering thickness gives players a very open and comfortable response as well as better feedback into their sound. The flat-dome bell rim helps players create their own personal tonal colors.

With the newest Custom Z, Yamaha kept the same basic design concepts—the precise lead pipe taper and super-efficient step bore—that made the original Z so popular. But Yamaha has improved on it in many subtle ways, often using techniques learned in developing the heavyweight Xeno Trumpets. As a result, the Custom Z offers an unprecedented amount of tonal richness and depth.

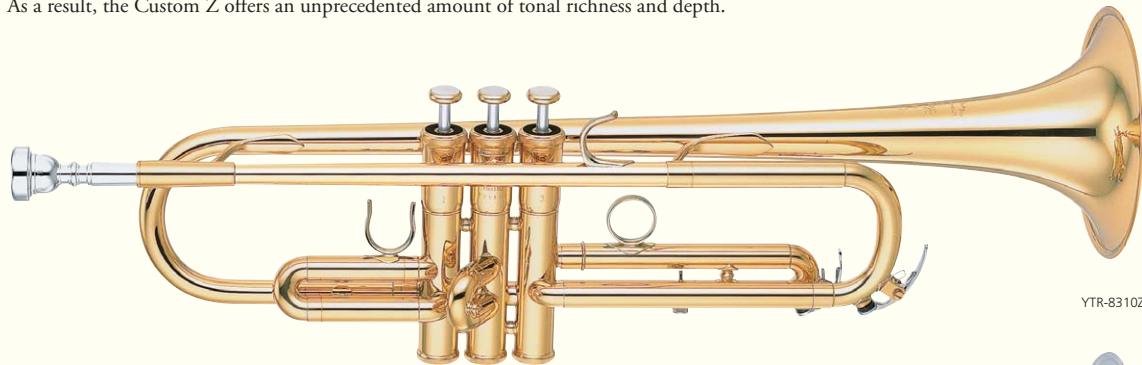

YTR-8310Z



YTR-8310ZS

### YTR-8310Z

Key=B $\flat$

Bell: one piece yellow brass, 127 mm (5")

Bore size: step bore – 11.3 mm (0.445")

Finish: gold lacquer

Mouthpiece: SHEW-JAZZ

With silver plate finish: YTR-8310ZS

# Professional Model Trumpets

## Perfect for All-Around Playing

Yamaha's professional medium-weight models are the perfect all-around trumpets. They're at home in any setting, from studio to big band, concert band, chamber group or orchestra. Yamaha offers several models to meet the needs of almost any player.

## B $\flat$ Trumpets



### YTR-6335

The YTR-6335 features a medium-large bore and a yellow-brass bell for a big sound with clear projection. It has the kind of flexibility needed for playing in a quintet or in the studio but enough tonal power for lead or orchestral work.

Key=B $\flat$

Bell: one piece yellow brass, 123 mm (4-7/8")

Bore size: ML – 11.65 mm (0.459")

Finish: gold lacquer

Mouthpiece: TR14B4

With silver plate finish: YTR-6335S



### YTR-6345G

The YTR-6345 offers a large-sized bore with a gold-brass bell for a warm, rich, commanding tone. Both are ideal for those who need versatility in their horn and are looking for an instrument that will play and sound just right in any group or setting.

Key=B $\flat$

Bell: one piece gold brass, 123 mm (4-7/8")

Bore size: L – 11.73 mm (0.462")

Finish: gold lacquer

Mouthpiece: TR14B4

With silver plate finish: YTR-6345GS



# Intermediate Model Trumpets

## There Are No Shortcuts in Pursuit of Musical Excellence

Yamaha's Intermediate Trumpets are high-quality instruments crafted using many of the technologies developed in producing our top-of-the-line professional models. Using a new production method we've created a two-piece bell that blows freely with rich, wide-ranging tone color. Tuning slides also utilize a new production method that produces an instrument higher in quality and easier to play.

### B $\flat$ Trumpets



YTR-4335GII

#### YTR-4335GII

The YTR-4335GII features a gold-brass bell that produces a richer, wider range of tonal colors. Durable yet light, the bell promotes easy endurance while playing. The richness of tone quality and freeblowing feel make this trumpet a great vehicle for those players looking to take their performance to the next level.

Key=B $\flat$

Bell: two piece gold brass, 123 mm (4-7/8")

Bore size: ML – 11.65 mm (0.459")

Finish: gold lacquer

Mouthpiece: TR11B4

With silver plate finish: YTR-4335GSII



TRC-400EII

Semi-hard case that can be carried in your hand, over your shoulder, or like a backpack.

### C/B $\flat$ Trumpets



YTR-4435SII

#### YTR-4435II

Incorporating know-how and technologies developed in the production of our high-end professional series trumpets, the YTR-4435II offers remarkable sound and playability. The tuning slide features a brace that brings more focus to the sound. Pitched in C, the instrument can be converted to B $\flat$  for greater versatility.

Key=C/B $\flat$

Bell: two piece yellow brass, 123 mm (4-7/8")

Bore size: ML – 11.65 mm (0.459")

Finish: gold lacquer

Mouthpiece: TR11B4

Extra tuning slides to convert to B $\flat$

With silver plate finish: YTR-4435SII



The YTR-4435II with B $\flat$  slides

# Student Model Trumpets

## Start Off on the Right Note—with the Right Trumpet

Yamaha's Student Model trumpet also owes much of its basic design to our professional series. Beginners will find it fun and easy to play and sound good on. This will help them learn to play in tune with a rich solid sound while establishing a strong musical foundation. Design focused first and foremost on creating a free blowing instrument, but we also thought long and hard about weight balance. An adjustable third valve trigger is added to accommodate different sized hands helping you master proper playing form. Highly durable pistons are made of monel alloy and soldered tuning slides offer extended durability and richer tone.

## B $\flat$ Trumpets



YTR-3335

### YTR-3335

The YTR-3335 is designed for players who are serious about their sound and ready to move up to a higher-grade instrument. Sharing the free blowing character of the YTR-2330, it plays smooth and comfortably with a matured, appealing tone. It also features a reversed leadpipe with a single brace for smoother, freer blowing.

Key=B $\flat$

Bell: two piece yellow brass, 123 mm (4-7/8")

Bore size: ML – 11.65 mm (0.459")

Finish: gold lacquer

Mouthpiece: TR11B4

With silver plate finish: YTR-3335S



YTR-3335S



### TRC-201EII

Semi-hard case with backpack style shoulder straps and carrying handles.



Reversed tuning slide enables easy blowing and smooth and comfortable feel in playing. (YTR-3335 only)

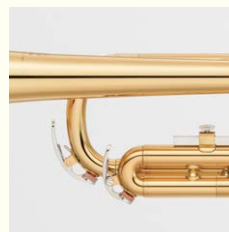

Third valve equipped with a water-key.





YTR-2330

## YTR-2330

The two-piece bell of the YTR-2330 is crafted using state-of-the-art production methods, delivering a consistent, vibrant tone. The balanced weight and addition of an adjustable third valve trigger allows for a natural hand position and promotes proper playing technique, while the water key on the third valve slide adds to the ease of use and over-all playability of the instrument.

Key=B $\flat$

Bell: two piece yellow brass, 123 mm (4-7/8")

Bore size: ML – 11.65 mm (0.459")

Finish: gold lacquer

Mouthpiece: TR11B4

With silver plate finish: YTR-2330S



YTR-2330S



### TRC-100EII

Bag style case with shoulder strap.

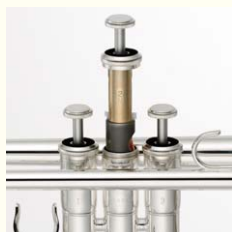

#### New piston, piston caps and buttons

Highly durable monel alloy pistons as well as newly designed piston buttons and bottom caps help lengthen the life of the instrument while also maximizing sound quality.



#### Lightweight yellow brass bell

The newly redesigned, durable yet light two-piece bell is made of yellow brass for optimal playability and to promote good technique and endurance.

## Specialized Instruments for Unique Compositions

Yamaha manufactures a wide array of instruments to meet the needs of specific styles of musical performance. Piccolo trumpets have a brilliant sound for Baroque or modern pieces. Rotary trumpets are indispensable for performances of German or Viennese classical or Romantic compositions. Flugelhorns will fill the hall with an extremely soft and mellow tone. And cornets demonstrate their ability in more rapid passages.

Yamaha collaborated with top artists performing all over the world stage in order to deliver this uncompromising range of instruments.





# B $\flat$ /A Piccolo Trumpets

## A Sound That Will Go Down in History

Although piccolo trumpets are generally used to play the difficult and high first trumpet parts from the Baroque era, more and more modern composers are creating contemporary pieces for these exciting instruments. Yamaha piccolo trumpets are easy to play and offer a beautiful sound with excellent intonation.



Acclaimed soloist Jens Lindemann has been the consultant for the Yamaha rotary piccolo trumpet, and Yamaha took a time to develop for 20 years. The new YTR-988 incorporates many original ideas that result in improved interval control, ease of playability and tubing with a completely original shape.

### YTR-988 — Custom Model —

The YTR-988 is a custom rotary piccolo trumpet that provides stable playability in addition to proper resistance and accurate intonation. The instrument can convert from the key of B $\flat$  to the key of A simply by switching the leadpipe.

Key=B $\flat$ /A

Bell: one piece yellow brass, 97.9 mm (3-15/16")

Bore size: S – 10.38 mm (0.409")

Finish: silver plate

Accessories: 2 leadpipes for key of B $\flat$  and A

Mouthpiece: TR11A5

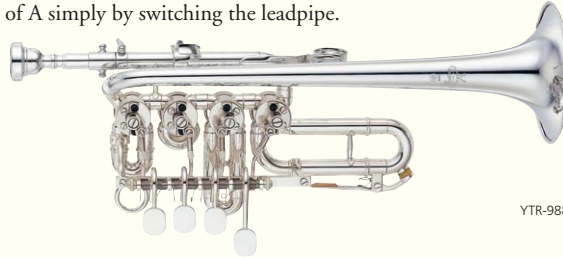

YTR-988

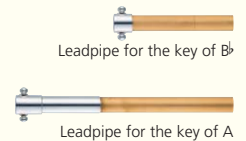

Leadpipe for the key of B $\flat$

Leadpipe for the key of A



#### Rotary Valve "Light-Touch" Mechanism

New rotary valves allow excellent playability without stress. A light valve action allows the player to concentrate on musical expression.



#### Adjustable Thumbhook (Movable Fingerhook)

We believe that "easy to hold means easy to play" and have adopted an adjustable thumbhook, allowing for adjustment of the orientation of the fixing ring or positional changes to suit the style of the player. This feature allows more stability when holding the instrument.

### YTR-9835 — Custom Model — *MalonePipe*

The YTR-9835 is a custom piccolo trumpet with four piston valves, resulting in a beautiful rich tone. YTR-9835 comes 4 leadpipes. Two leadpipes have trumpet mouthpiece receivers in B $\flat$  and A while the other two have cornet mouthpiece receivers in B $\flat$  and A.

Key=B $\flat$ /A

Bell: one piece yellow brass, 101 mm (4")

Bore size: M – 11.3 mm (0.445")

Finish: silver plate

Accessories: 4 leadpipes; B $\flat$  and A for trumpet shank, and B $\flat$  and A for cornet shank, and a leadpipe pouch.

Mouthpiece: TR11A5, CR11A4

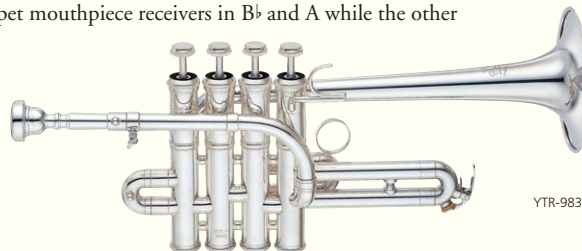

YTR-9835

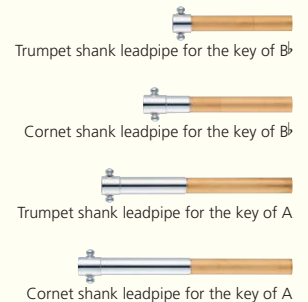

Trumpet shank leadpipe for the key of B $\flat$

Cornet shank leadpipe for the key of B $\flat$

Trumpet shank leadpipe for the key of A

Cornet shank leadpipe for the key of A

### YTR-9825 — Custom Model — *MalonePipe*

The YTR-9825 is a custom piccolo trumpet with three piston valves to create a light bright tone. The trigger is adjustable and easy to hold. YTR-9825 comes 4 leadpipes. Two leadpipes have trumpet mouthpiece receivers in B $\flat$  and A while the other two have cornet mouthpiece receivers in B $\flat$  and A.

Key=B $\flat$ /A

Bell: one piece yellow brass, 101 mm (4")

Bore size: M – 11.3 mm (0.445")

Finish: silver plate

Accessories: 4 leadpipes; B $\flat$  and A for trumpet shank, and B $\flat$  and A for cornet shank, and a leadpipe pouch.

Mouthpiece: TR11A5, CR11A4



YTR-9825



Leadpipe pouch

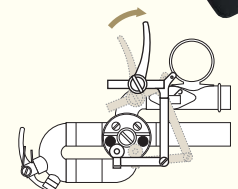

#### Rotary System of YTR-9825

If the trigger is pulled when the third piston is depressed, the note can be reduced by a whole tone to expand the low register.

### YTR-6810 — Professional Model —

This professional piccolo trumpet has a smaller bell and bore size, producing a sound more suitable for solo or chamber music. This model has four piston valves and B $\flat$ /A exchangeable leadpipes.

Key=B $\flat$ /A

Bell: one piece yellow brass, 94 mm (3-3/4")

Bore size: S – 10.5 mm

Finish: gold lacquer

Accessories: 2 leadpipes for key of B $\flat$  and A

Mouthpiece: TR14A4a

With silver plate finish: YTR-6810S

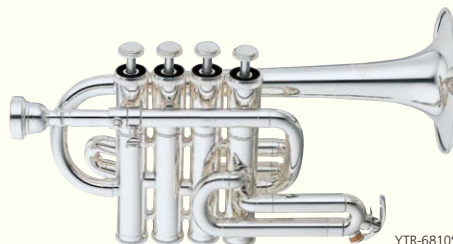

YTR-6810

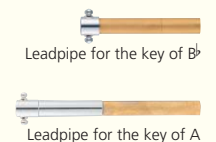

Leadpipe for the key of B $\flat$

Leadpipe for the key of A

# E, E $\flat$ & D Trumpets

## Hitting the High Notes

With their brilliant sound, clear and crisp attack, and excellent control in the high register, these trumpets were originally used mainly for performance of Baroque music. But now they are increasingly played as an alternative to B $\flat$  and C trumpets, especially for hitting treacherous passages in the upper registers.

### E $\flat$ Trumpet

#### YTR-9630 — Custom Model —

With a larger bell than other E $\flat$  trumpets, Yamaha's custom YTR-9630 creates a large warm sound. The fourth valve reaches the low register, resulting in greater fullness in volume and sound.

Key=E $\flat$

Bell: one piece gold brass, 127 mm (5")

Bore size: M – 11.3 mm (0.445")

Finish: silver plate

Mouthpiece: TR14B4

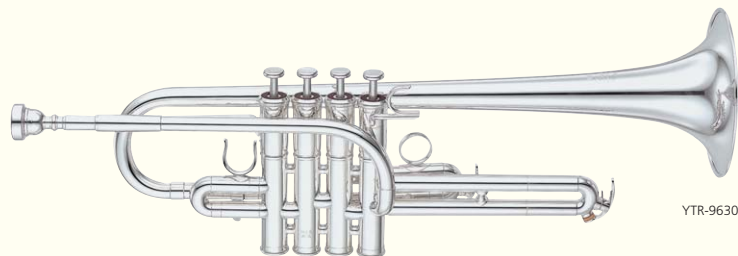

YTR-9630

### E/E $\flat$ Trumpets

#### YTR-9635 — Custom Model —

This heavyweight model combines a full and robust tone with superior playability. Performers can easily transition between E and E $\flat$  keys by exchanging the bell and first and third valve slides.

Key=E/E $\flat$

Bell: one piece yellow brass, 123 mm (4-7/8")

Bore size: ML – 11.65 mm (0.459")

Finish: silver plate

Accessories: E $\flat$  Bell, first and third valve slides

Mouthpiece: TR14B4



YTR-9635

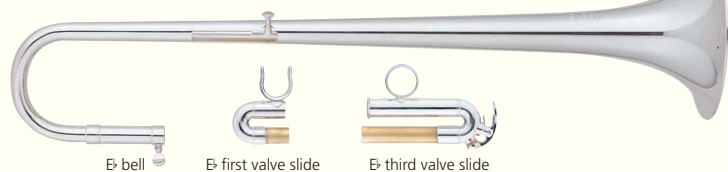

E $\flat$  bell

E $\flat$  first valve slide

E $\flat$  third valve slide

### E $\flat$ /D Trumpets

#### YTR-9636 — Custom Model — *MalonePipe*

The YTR-9636 model has a rich and attractive tone and is widely used in both solo and orchestral performance due to its natural ability to shift from C. It has a newly designed leadpipe with a unique shape. Transitioning between D and E $\flat$  involves changing the main tuning slide and first and third valve slides rather than by changing the bell.

Key=E $\flat$ /D

Bell: one piece yellow brass, 123 mm (4-7/8")

Bore size: ML – 11.65 mm (0.459")

Finish: silver plate

Accessories: D main tuning slide and first and third valve slides

Mouthpiece: TR14B4

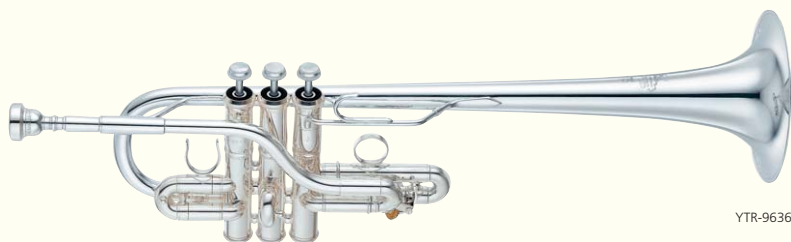

YTR-9636

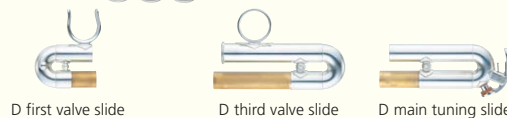

D first valve slide

D third valve slide

D main tuning slide

#### YTR-9610 — Custom Model —

The YTR-9610 is a custom-made E $\flat$ /D trumpet that has proper resistance and accurate intonation for performers to play a full variety of musical genres from solo or chamber music to full orchestral compositions. The trumpet's lightweight design provides an attractive combination of agile response and pleasant playing. Switching between the keys of E $\flat$  and D involves exchanging the bell and the first and third valve slides.

Key=E $\flat$ /D

Bell: one piece yellow brass, 120 mm (4-3/4")

Bore size: M – 11.3 mm (0.445")

Finish: silver plate

Accessories: D bell and first and third valve slides

Mouthpiece: TR14B4



YTR-9610

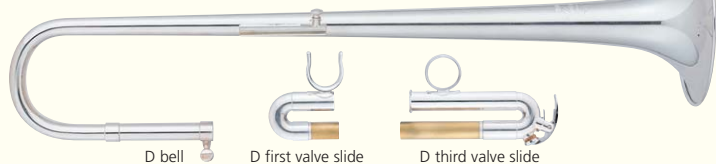

D bell

D first valve slide

D third valve slide



## YTR-6610S — Professional Model —

The YTR-6610S is a lightweight professional model that continues Yamaha's tradition of excellence by providing agile response and accurate intonation. Switching between the key of E $\flat$  and D involves exchanging the main tuning slide and the first and third valve slides.

Key=E $\flat$ /D

Bell: one piece yellow brass, 120 mm (4-3/4")

Bore size: M – 11.3 mm (0.445")

Finish: silver plate

Accessories: D main tuning slide and first and third valve slides

Mouthpiece: TR14B4

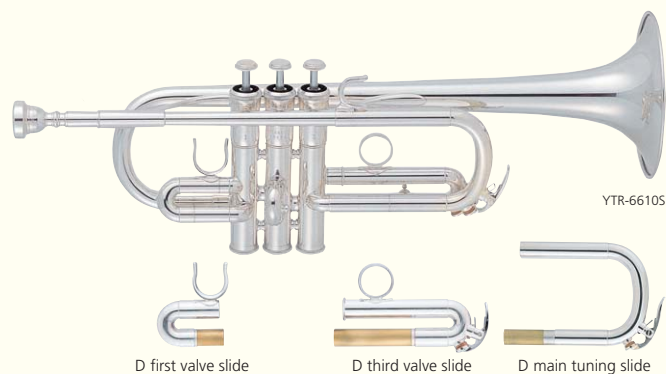

## G/F Trumpet

### Expressing Your Unique Style

This custom trumpet responds to a wide range of expressive styles and has a brilliant high register. Performers can switch the instrument from the key of G to the key of F by exchanging the bell and valve slides.

## YTR-9710 — Custom Model —

Key=G/F

G Bell: one piece yellow brass, 101 mm (4")

F Bell: one piece gold brass, 110 mm (4-1/3")

Bore size: M – 11.3 mm (0.445")

Finish: silver plate

Accessories: F bell and first and third valve slides

Mouthpiece: TR14A4a

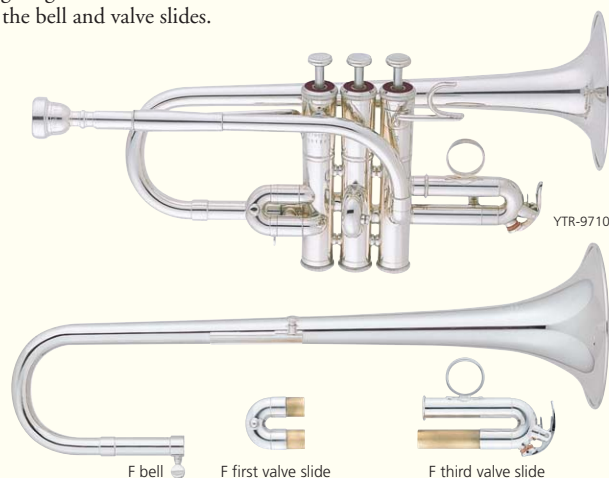

## Herald Trumpet

### A Sound That Will Tug at Your Heartstrings

Yamaha's herald trumpet produces a sharp sound that will resonate brilliantly when playing fanfares. The elongated characteristic bell has two rings for mounting a flag.

## YTR-6330F — Professional Model —

Key=B $\flat$

Bell: one piece yellow brass, 123 mm (4-7/8")

Bore size: ML – 11.65 mm (0.459")

Finish: clear lacquer

Accessories: F bell and first and third valve slides

Mouthpiece: TR14B4

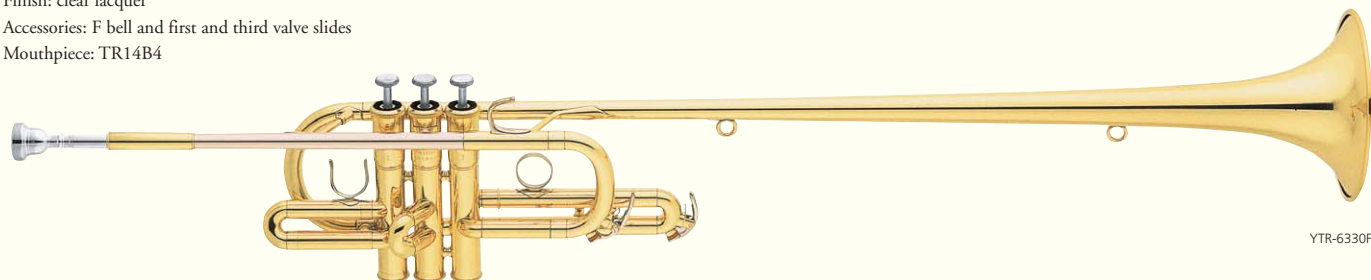

# Rotary Trumpets

## Known the World Over

Following German tradition, Yamaha's innovative new rotary trumpet produces an expressive tone and superior playability. With its warmth and depth, the instrument resonates naturally with other instruments, even in a full orchestra.



Markus Bebek, first trumpet with the Frankfurt Opera Orchestra, acts as Yamaha's new rotary trumpet consultant. Yamaha's know-how applied to Bebek's ideas led to the birth of a new era in sound balance and creation of a tone that is both brilliant and soft.

### YTR-938FFMS/YTR-938FFMGS — Custom Model —

Yamaha's newly designed YTR-938FFMS has been developed in collaboration with musicians from a Frankfurt atelier\*. Yamaha's new "light-touch mechanism" has been applied to the rotary valves, resulting in a highly responsive "lever action."

\*Frankfurt atelier moved to Hamburg in April 2009.

Key=B $\flat$

Bell: one piece yellow brass (YTR-938FFMS), one piece gold brass (YTR-938FFMGS), 138 mm (5-7/16")

Bore size: M – 11.24 mm (0.442")

Finish: silver plate

Mouthpiece: TR16E4

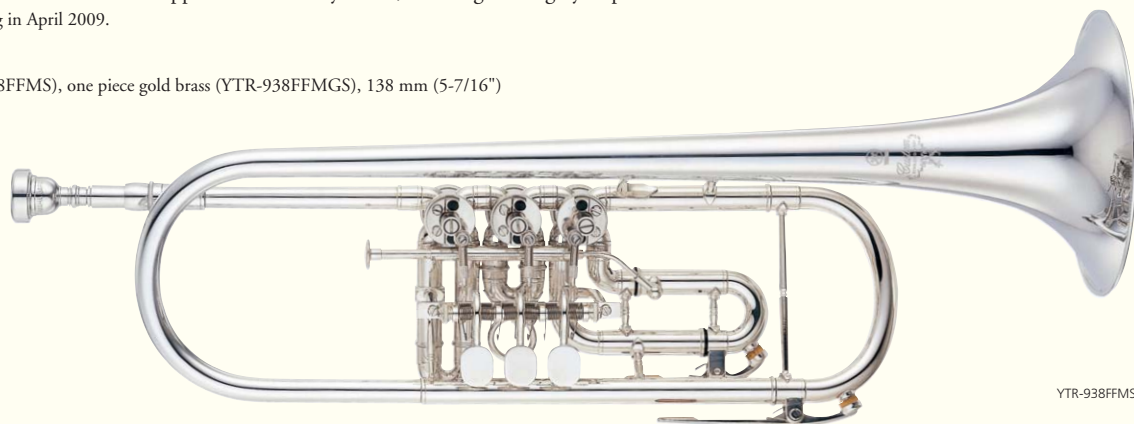

YTR-938FFMS

### YTR-948FFMS/YTR-948FFMGS — Custom Model —

Like the YTR938FFMS, the newly designed YTR-948FFMS rotary C trumpet incorporates many innovations.

Yamaha's new "light-touch mechanism" has been applied to the rotary valves, and a high C key has been added as a standard feature on the tuning slide.

Key=C

Bell: one piece yellow brass (YTR-948FFMS), one piece gold brass (YTR-948FFMGS), 130 mm (5-1/8")

Bore size: M – 11.24 mm (0.442")

Finish: silver plate

Mouthpiece: TR16E4

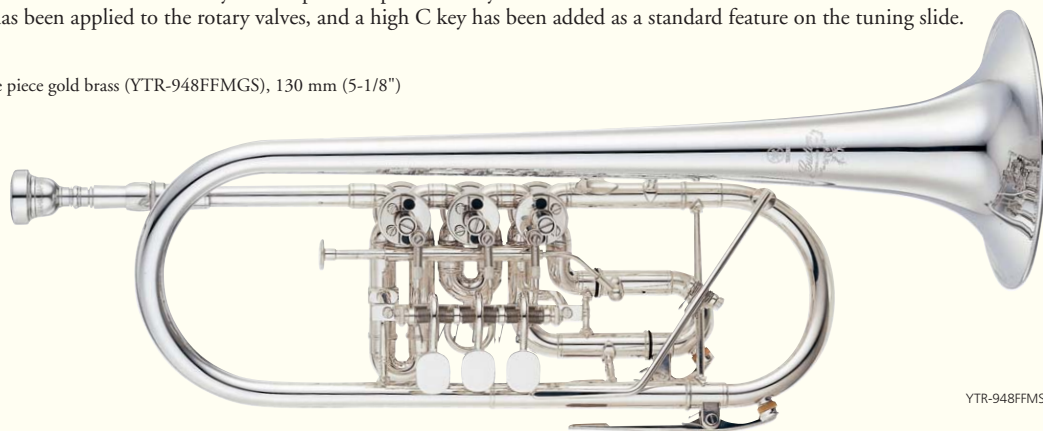

YTR-948FFMS

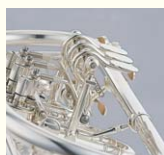

#### Rotary Valve "Light-Touch Mechanism"

New rotary valves allow excellent playability without stress on musicians' fingers. The light valve action allows the player to concentrate on musical expression.

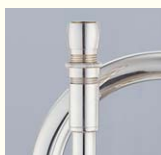

#### Adjustable Mouthpiece Receiver

The space between the mouthpiece and the leadpipe can be adjusted to suit a player's preferences in resistance and playability.



# Flugelhorns

## A Deep Resonance, Sweet and Beautiful

Flugelhorns have a soft, mellow, dark sound with beautiful lyrical qualities; they are especially favored for jazz ballads. Yamaha has overcome the intonation challenges typically associated with older flugelhorns and offer a very comfortable response.

### YFH-8310Z — Custom Model — *MalonePipe*

The YFH-8310Z combines the tonal richness and depth of character of the older traditional flugels with the easy playability and superb intonation made possible by high-tech engineering. Inspired by legendary artist Bobby Shew, the Z features the perfect amount of air resistance to let you color the sound—your sound—exactly the way you want to. And it slots so nicely in the upper register you'll forget you're playing a flugelhorn.

Key=B $\flat$

Bell: one piece yellow brass, 151.8 mm (6")

Bore size: S – 10.5 mm (0.413")

Finish: clear lacquer, third valve slide trigger

Mouthpiece: SHEW-FH

With gold brass bell : YFH-8310ZG

With silver plate finish : YFH-8310ZS/8310ZGS



YFH-8310Z

### YFH-8315G — Custom Model — *MalonePipe*

The YFH-8315G has been developed in collaboration with musicians from a New York and Los Angeles atelier. The new generation instrument uses a two-piece bell, etc to deliver a soft tone with outstanding presence.

Key=B $\flat$

Bell: two piece gold brass, 151.8 mm (6")

Bore size: S – 10.5 mm (0.413")

Finish: clear lacquer, third valve slide trigger

Mouthpiece: FH14F4

With silver plate finish: YFH-8315GS

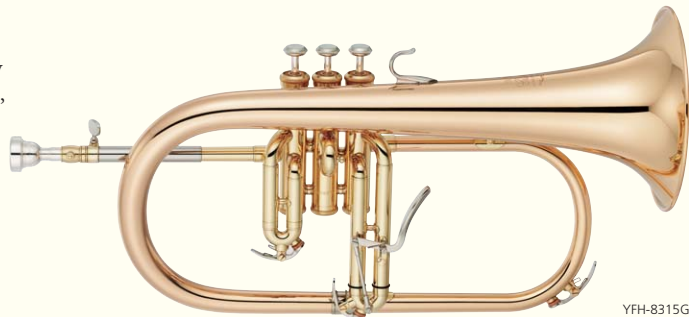

YFH-8315G

#### New Trigger System



The newly designed third valve slide trigger is more ergonomic and will accommodate a wider range of hand sizes.

#### New Leadpipe Design



YFH-8310Z



YFH-8315G

New flugelhorn I features a newly designed leadpipe, outer leadpipe area and a new connection brace between the leadpipe and the valve casing.

### YFH-631G — Professional Model —

The YFH-631G is easy to play in a traditional style and has a broad and rich tonal range. Proper intonation can be achieved by adjusting the third valve slide trigger.

Key=B $\flat$

Bell: two piece gold brass, 151.8 mm (6")

Bore size: MS – 11 mm (0.433")

Finish: clear lacquer, third valve slide trigger

Mouthpiece: FH11F4

With silver plate finish: YFH-631GS

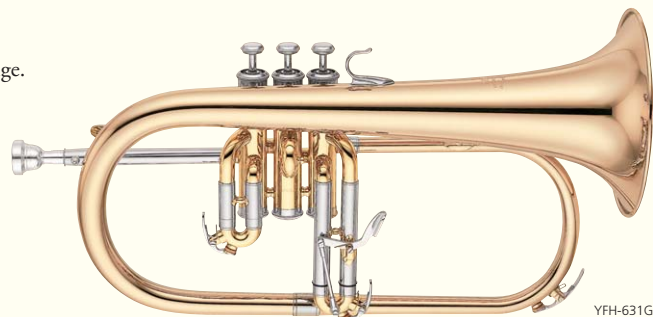

YFH-631G

### YFH-2310 — Student Model —

The YFH-2310 student model has a simple and solid construction with dependable sound. This model offers high performance with high quality at an affordable price.

Key=B $\flat$

Bell: two piece yellow brass, 151.8 mm (6")

Bore size: M – 11.3 mm (0.445")

Finish: clear lacquer

Mouthpiece: FH11F4

With silver plate finish: YFH-2310S



YFH-2310

# Cornets

## In Constant Pursuit of Perfect Music

The Yamaha cornet responds to the varied demands of a performer. Yamaha's long experience in the manufacture of instruments can be seen in every detail of these cornets. Artists performing all over the world have been in constant communication with Yamaha's research and development team to further advance the musicality of these horns.

## Xeno B $\flat$ & E $\flat$ Models



The Xeno name has become well-established as the brand of choice for discerning trumpet and trombone players. And now Yamaha has incorporated previous learnings into the development of some new cornets. The Xeno cornets were developed in close collaboration with some of the world's best players, including David King who is an acclaimed cornet soloist, head of performance studies at the University of Salford and principal conductor of the Yorkshire Building Society band. King worked closely with Yamaha's Frankfurt-based research and development expert Thomas Lubitz for more than two years to develop these cutting-edge instruments.

### YCR-8335

The YCR-8335 is the B $\flat$  cornet in the Xeno series. Yamaha's instruments resonate with the soft and brilliant sounds in the tradition of British Brass Bands. Audience will be mesmerized by the rich expressiveness of emotion and deep tonal qualities produced by these instruments.

Key=B $\flat$

Bell: one piece yellow brass, 125.5 mm (5")

Bore size: L – 11.9 mm (0.469")

Finish: clear lacquer, first and third valve slide triggers

Mouthpiece: KING

With gold brass bell: YCR-8335G

With silver plate finish: YCR-8335S/8335GS



YCR-8335

### YCR-8620S

The YCR-8620S E $\flat$  cornet in the Xeno series produces a dark, rich sound. Its new one-piece bell design with thinner shape and modified taper allow the sound to resonate and project more freely while its curved leadpipe with sleeve and redesigned bell braces provide the appropriate amount of resistance.

Key=E $\flat$

Bell: one piece yellow brass, 120 mm (4-3/4")

Bore size: ML – 11.3 mm (0.445")

Finish: silver plate

Mouthpiece: CR6B4 (L)



YCR-8620S

## Custom C Model

Incorporating input from consultant John Hagstrom from the Chicago Symphony Orchestra, the Custom cornet features french bead wire and side seams. Trumpet shanks allow for smooth exchanging from trumpet to cornet. Yamaha's design supports the performer by creating a strong, brilliant, complex sound in a volume that is required during orchestral performances.

### YCR-9435 *Malone Pipe*

Key=C

Bell: one piece yellow brass, 123 mm (4-7/8")

Bore size: ML – 11.65 mm (0.459")

Finish: silver plate

Mouthpiece: TR16C4



YCR-9435

## Professional B $\flat$ Models

The YCR-6330II is a high-performance model with a one-piece yellow-brass bell, resulting in smooth continuous airflow and a deep rich resonance.

### YCR-6330II

Key=B $\flat$

Bell: one piece yellow brass, 119 mm (4-2/3")

Bore size: ML – 11.73 mm (0.462")

Finish: clear lacquer

Mouthpiece: CR11E4 (S)

With silver plate finish: YCR-6330SII



YCR-6330II



## Intermediate B $\flat$ Models

### YCR-4330GII

The YCR-4330GII which includes a newly designed rounded leadpipe in combination with a ML-Bore offers the typical cornet sound with a very easy response. The modified two-piece gold brass bell with ideal thickness enables the player to create a round and warm tone.

Key=B $\flat$

Bell: two piece gold brass, 119 mm (4-2/3")

Bore size: ML – 11.65 mm (0.459")

Finish: gold lacquer

Mouthpiece: CR11E4 (S)

With silver plate finish: YCR-4330GSII



YCR-4330GII

## Student B $\flat$ & E $\flat$ Models

We've incorporated what we've learned from our high-end professional models into a new line of Student Cornets that offer remarkably improved tone and free blowing. All instruments utilize a two-piece bell crafted with a newly developed production method. They also feature well-balanced designs that make them easier to hold and improve durability. Pistons are made of the monel alloy and soldered tuning slides offer extended durability and richer tone.

### YCR-2330III

The YCR-2330III is an excellent introductory model that features a "Shepherd's Crook" bell style, a rounded leadpipe and a ML (medium-large) bore for smooth and light playability with a soft, warm tone. An adjustable third valve trigger accommodates different sized hands helping the player develop proper playing technique.

Key=B $\flat$

Bell: two piece yellow brass, 119 mm (4-2/3")

Bore size: ML – 11.65 mm (0.459")

Finish: gold lacquer

Mouthpiece: CR11E4 (S)

With silver plate finish: YCR-2330SIII



YCR-2330III

### YCR-2310III

The YCR-2310III is an excellent introductory model that features a rounded leadpipe and ML (medium-large) bore for smooth and light response with a soft, warm tone. An adjustable third valve trigger accommodates different sized hands helping the player develop proper playing technique.

Key=B $\flat$

Bell: two piece yellow brass, 119 mm (4-2/3")

Bore size: ML – 11.65 mm (0.459")

Finish: gold lacquer

Mouthpiece: CR11C4 (L)

With silver plate finish: YCR-2310SIII



YCR-2310III

### YCR-2610SIII

The YCR-2610SIII beginner's E $\flat$  cornet has a movable fingerhook that can be adjusted for smaller hands and allows the student to learn a correct fluid method of playing.

Key=E $\flat$

Bell: two piece yellow brass, 119 mm (4-2/3")

Bore size: ML – 11.65 mm (0.459")

Finish: silver plate

Mouthpiece: CR7D4d (S)



YCR-2610SIII



#### New piston, piston caps and buttons

Highly durable monel alloy pistons as well as newly designed piston buttons and bottom caps help lengthen the life of the instrument while also maximizing sound quality.



#### Lightweight yellow brass bell

The newly redesigned, durable yet light two-piece bell is made of yellow brass for optimal playability and to promote good technique and endurance.



#### Round shape lead pipe

The redesigned rounded leadpipe give this instrument a smooth and light response and a warm tone quality.

# Yamaha Trumpet Mouthpieces

All Yamaha brass mouthpieces have been designed in cooperation with the world's top players and are produced on space-age computer lathes, virtually guaranteeing that every mouthpiece with the same model number will play, sound and feel precisely the same. We offer four different series to suit any playing requirements.



## Student Series

Yamaha's Student Series mouthpieces allows for smooth attack, secure control and easy playability. They offer a perfect weight balance for all-around usage and are available in a wide variety of options for inner diameter, thickness, cup depth, throat dimensions and backbore width.



## GP Series

The GP Series are heavyweight with a shape ideal for players who want a strong, focused sound. The rim, cup and inner bore are gold-plated for superior projection and smooth response.



## Silver 925 Series

Yamaha is proud to offer the first sterling silver production mouthpieces in the world. Made of 92.5% pure silver, the material is very dense for a dark focused sound with surprising power and projection.

### ■ Trumpet—Student Series

Model No.	Inner Diameter	Contour	Thickness	Cup Depth	Throat	Backbore	Approximate Size Equivalent
5A4	15.90 mm	semi-flat	thick	shallow	3.65 mm	narrow	Bob Reeves OES 69
6A4a	15.90 mm	semi-flat	thick	shallow	3.65 mm	narrow	Schilke 6A4a
7A4	16.24 mm	semi-flat	thick	shallow	3.65 mm	narrow	Purviance 4 (4*D4)
7B4	16.08 mm	semi-flat	thick	semi-shallow	3.72 mm	standard	Schilke 7B4
8C4	16.19 mm	semi-flat	standard	standard	3.65 mm	semi-narrow	Bach 10 1/2C
9C4	16.28 mm	semi-flat	standard	standard	3.65 mm	semi-narrow	Bach 7C, smaller rim diameter
11A4	16.46 mm	semi-flat	semi-thick	shallow	3.65 mm	semi-narrow	Bach 7E
11A5	16.38 mm	semi-flat	thick	shallow	3.65 mm	semi-wide	Bach 7EW
11B4	16.46 mm	semi-flat	standard	semi-shallow	3.65 mm	semi-narrow	Bach 7D
11	16.32 mm	standard	semi-thick	standard	3.72 mm	standard	Schilke 11
11C4	16.46 mm	semi-flat	standard	standard	3.65 mm	semi-narrow	Bach 7C, Giardinelli 7C
13A4a	16.20 mm	semi-flat	thick	shallow	3.65 mm	narrow	Schilke 13A4a
13B4	16.63 mm	semi-flat	standard	semi-shallow	3.65 mm	semi-narrow	Bach 6C
13C4	16.50 mm	semi-flat	standard	standard	3.65 mm	semi-narrow	Bach 6B
13D4	16.68 mm	semi-flat	standard	semi-deep	3.65 mm	semi-narrow	Bach 6
14A4a	16.68 mm	semi-flat	semi-thick	shallow	3.65 mm	narrow	Schilke 14A4a, Giardinelli 6S
14B4	16.85 mm	semi-flat	standard	semi-shallow	3.65 mm	semi-narrow	Bach 3C, Schilke 15B
14C4	16.88 mm	semi-flat	standard	standard	3.65 mm	semi-narrow	Bach 5C, Giardinelli 5C
14D4	16.80 mm	semi-flat	standard	semi-deep	3.65 mm	semi-narrow	Bach 5B
14E4	16.84 mm	semi-flat	semi-thick	deep	3.88 mm	wide	Bach 3C rim, very deep cup
15B4	16.96 mm	semi-flat	standard	semi-shallow	3.65 mm	semi-narrow	Bach 2C, shallower cup
15C4	16.98 mm	semi-flat	standard	standard	3.65 mm	semi-narrow	Bach 2C
15E4	16.92 mm	semi-flat	semi-thick	deep	3.88 mm	wide	Bach 2C rim, very deep cup
16C4	17.00 mm	semi-flat	standard	standard	3.65 mm	semi-narrow	Bach 1 1/2C
16D	17.14 mm	standard	standard	semi-deep	3.65 mm	semi-narrow	Bach 1 1/2C, deeper cup
16E4	17.14 mm	semi-flat	semi-thick	deep	3.88 mm	wide	Bach 1 1/2C rim, very deep cup
17B4	17.30 mm	semi-flat	standard	semi-shallow	3.65 mm	semi-narrow	Bach 1 1/4C
17C4	17.30 mm	semi-flat	standard	standard	3.65 mm	semi-narrow	Bach 1C
17D4	17.30 mm	semi-flat	standard	semi-deep	3.65 mm	semi-narrow	Bach 1C, deeper cup
18C4	17.42mm	semi-flat	standard	standard	3.65 mm	semi-narrow	Bach 1

### ■ Trumpet—GP Series

Model No.	Inner Diameter	Contour	Thickness	Cup Depth	Throat	Backbore	Approximate Size Equivalent
7A4-GP	16.24 mm	semi-flat	thick	shallow	3.65 mm	narrow	Purviance 4 (4*D4)
8C4-GP	16.19 mm	semi-flat	standard	standard	3.65 mm	semi-narrow	Bach 10 1/2C, Giardinelli 10C
11B4-GP	16.46 mm	semi-flat	standard	semi-shallow	3.65 mm	semi-narrow	Bach 7D
14A4a-GP	16.68 mm	semi-flat	semi-thick	shallow	3.65 mm	semi-narrow	Schilke 14A4a, Giardinelli 6S
14B4-GP	16.85 mm	semi-flat	standard	semi-shallow	3.65 mm	semi-narrow	Bach 3C, Schilke 15B
14C4-GP	16.88 mm	semi-flat	standard	standard	3.65 mm	semi-narrow	Bach 5C, Giardinelli 5C
16C4-GP	17.00 mm	semi-flat	standard	standard	3.65 mm	semi-narrow	Bach 1 1/2C
17C4-GP	17.30 mm	semi-flat	standard	standard	3.65 mm	semi-narrow	Bach 1C

### ■ Trumpet—Silver 925 Series

Model No.	Inner Diameter	Contour	Thickness	Cup Depth	Throat	Backbore	Approximate Size Equivalent
7A4-ST	16.24 mm	semi-flat	thick	shallow	3.65 mm	narrow	Purviance 4 (4*D4)
11B4-ST	16.46 mm	semi-flat	standard	semi-shallow	3.65 mm	semi-narrow	Bach 7D
14A4a-ST	16.68 mm	semi-flat	semi-thick	shallow	3.65 mm	semi-narrow	Schilke 14A4a, Giardinelli 6S
14B4-ST	16.85 mm	semi-flat	standard	shallow	3.65 mm	semi-narrow	Bach 3C, Schilke 15B
16C4-ST	17.00 mm	semi-flat	standard	standard	3.65 mm	semi-narrow	Bach 1 1/2C

## ■ Cornet—Student Series (Short Shank)

Model No.	Inner Diameter	Contour	Thickness	Cup Depth	Throat	Backbore	Approximate Size Equivalent
7D4d	16.24 mm	semi-flat	thick	semi-deep	4.10 mm	semi-wide	Denis Wick S
8D2	16.36 mm	semi-round	standard	semi-deep	4.10 mm	wide	Denis Wick S, larger rim diameter
9E	16.44 mm	standard	standard	deep	4.50 mm	semi-wide	Denis Wick 5
11C4	16.46 mm	semi-flat	standard	standard	3.65 mm	semi-narrow	Bach 7C
11E4	16.46 mm	semi-flat	standard	deep	4.20 mm	standard	Denis Wick 4B
13E4	16.70 mm	semi-flat	standard	deep	4.50 mm	standard	Denis Wick 4
14E	16.86 mm	standard	standard	deep	3.98 mm	standard	Denis Wick 3, deep U cup
16E	17.06 mm	standard	standard	deep	3.98 mm	standard	Denis Wick 2, deep U cup

## ■ Cornet—Student Series (Long Shank)

Model No.	Inner Diameter	Contour	Thickness	Cup Depth	Throat	Backbore	Approximate Size Equivalent
6B4	15.65 mm	semi-flat	semi-thick	semi-shallow	3.76 mm	standard	Bach 17C
7A4	16.24 mm	semi-flat	thick	shallow	3.65 mm	standard	Purviance 4 (4*D4)
9C4	16.28 mm	semi-flat	standard	standard	3.65 mm	standard	Bach 7C, smaller rim diameter
11A4	15.99 mm	semi-flat	standard	shallow	3.65 mm	semi-narrow	Schilke 11AX
11B4	16.64 mm	semi-flat	standard	shallow	3.65 mm	semi-wide	Bach 7E
11C4	16.46 mm	semi-flat	standard	standard	3.65 mm	standard	Bach 7C, Giardinelli 7C
13B4	16.63 mm	semi-flat	standard	semi-shallow	3.65 mm	standard	Bach 6C
14A4a	16.68 mm	semi-flat	standard	shallow	3.65 mm	standard	Schilke 14A4X
14B4	16.85 mm	semi-flat	standard	semi-shallow	3.65 mm	standard	Bach 3C, Schilke 15B
15C4	16.98 mm	semi-flat	standard	standard	3.65 mm	standard	Bach 2C
16C4	17.00 mm	semi-flat	standard	standard	3.65 mm	standard	Bach 1 1/2C
17C4	17.30 mm	semi-flat	standard	standard	3.65 mm	standard	Bach 1C

## ■ Cornet—GP Series (Short Shank)

Model No.	Inner Diameter	Contour	Thickness	Cup Depth	Throat	Backbore	Approximate Size Equivalent
14E-GP	16.86 mm	standard	standard	deep	3.98 mm	standard	Denis Wick 3, deep U cup
16E-GP	17.06 mm	standard	standard	deep	3.98 mm	standard	Denis Wick 2, deep U cup

## ■ Flugelhorn—Student Series

Model No.	Inner Diameter	Contour	Thickness	Cup Depth	Throat	Backbore	Approximate Size Equivalent
7F4	16.24 mm	semi-flat	thick	deep	4.30 mm	standard	Giardinelli 10FL
11F4	16.46 mm	semi-flat	standard	standard	3.80 mm	standard	Bach 7FL
13F4	16.66 mm	semi-flat	standard	standard	4.30 mm	standard	Giardinelli 7FL
14F4	16.76 mm	semi-flat	standard	standard	4.30 mm	standard	Giardinelli 7FL, larger rim diameter
16F4	17.00 mm	semi-flat	standard	deep	4.30 mm	standard	Giardinelli 3FL
17F4	17.22 mm	semi-flat	standard	deep	4.50 mm	standard	Giardinelli 3FL, larger rim diameter

## ■ Flugelhorn—GP Series

Model No.	Inner Diameter	Contour	Thickness	Cup Depth	Throat	Backbore	Approximate Size Equivalent
14F4-GP	16.76 mm	semi-flat	standard	standard	4.30 mm	standard	Giardinelli 7FL, larger rim diameter

## Signature Series Mouthpieces

For years many of the greatest talents in the world have been going to Yamaha's research and development centers to work with design experts who create their dream mouthpieces. Originally these mouthpieces were produced only for the personal use of the individual artists. But now, after numerous requests from their colleagues and students, Yamaha has made these special designs available to all.

### ■ Signature Series

Artist		Model No.	Inner Diameter	Contour	Thickness	Cup Depth	Throat	Backbore
Allen Vizzutti	for Trumpet	VIZZUTTI	16.67 mm	semi-flat	semi-thick	shallow	3.56 mm	narrow
Bobby Shew	for Trumpet	SHEW-LEAD	16.54 mm	semi-round	semi-thick	shallow	3.56 mm	narrow
	for Trumpet	SHEW-JAZZ	16.85 mm	semi-round	semi-thick	standard	3.65 mm	standard
	for Flugelhorn	SHEW-FH	16.54 mm	semi-round	semi-thick	standard	4.40 mm	long taper
Rod Franks	for Trumpet	FRANKS	16.82 mm	semi-flat	semi-thick	standard	3.91 mm	narrow
Eric Miyashiro	for Trumpet	EM1	16.02 mm	semi-round	thin	shallow	3.65 mm	narrow
	for Trumpet	EM2	16.22 mm	semi-round	thin	shallow	3.65 mm	narrow
	for Flugelhorn	EM-FH	16.06 mm	semi-flat	thin	standard	4.40 mm	long taper
Fritz Damrow	for Trumpet	TR-DAMROW-S	16.98 mm	standard	standard	standard	3.88 mm	standard
Eric Aubier	for Trumpet	TR-AUBIER-S	17.03 mm	semi-flat	standard	standard	3.80 mm	standard
Mark Gould	for Trumpet	MG	17.30 mm	standard	standard	semi-shallow	3.88 mm	standard
David King	for Cornet	DKINGS-S	16.91 mm	standard	standard	deep	4.60 mm	semi-narrow
Pierre Dutot	for Cornet	CR-DUTOT-S	16.90 mm	standard	standard	deep	3.99 mm	wide
	for Cornet	CR-DUTOT-L	16.95 mm	standard	standard	shallow	3.72 mm	standard
	for Flugelhorn	FH-DUTOT	17.20 mm	semi-flat	standard	deep	3.99 mm	narrow

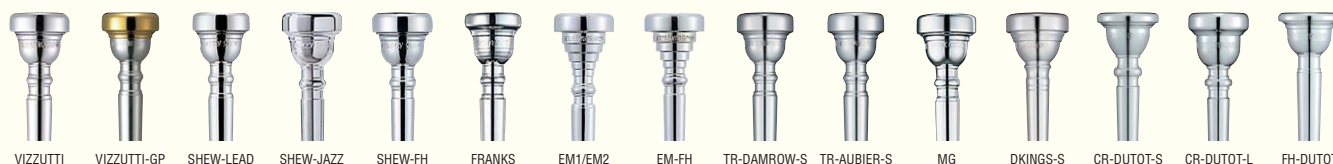



# What Artists are Saying About Yamaha Trumpets...



**Eric Aubier** (France)  
International Soloist.

"Yamaha trumpets are technically superior and contain the potential for a wide range of tonal colors and nuances. They are not artistic on their own but offer you a tool to express your own artistry."



**Rüdiger Baldauf** (Germany)  
Jazz Soloist.

"I play Yamaha Trumpets and Flugelhorns because I can concentrate on the music from the first note. These instruments make my job easier and fulfill all of my expectations."



**Markus Bebek** (Germany)  
Associate Principal Trumpet of the Opera Frankfurt am Main.

"For me Yamaha is the perfect partner at my jobs in the orchestra, ensembles or as a soloist. Yamaha instruments and customer service fulfill all my desires."



**Wayne Bergeron** (US)  
One of the Most Sought-After West Coast Studio Players.

"Since my line of work covers a lot of ground musically, I need an instrument that responds to these needs. The YTR-8335LA is the most versatile Bb trumpet I have ever played. It delivers the full spectrum of tone colors needed to get the job done from the scoring stage to soaring over a big band."



**Jeroen Berwaerts** (Belgium)  
Professor Musikhochschule Hannover, Member of Canadian Brass, Principal Trumpet NDR Symphony Orchestra (Hamburg, Germany).

"With the Xeno Trumpet, I'm flexible—whether as a soloist or in the orchestra. From classical to jazz, I get the sound that I'm looking for."



**Randy Brecker** (US)  
Grammy-Award Winning Jazz, R&B and Rock Soloist.

"Yamaha Trumpets and Flugelhorns have been keeping me happy for many years. The workmanship is very consistent, the tuning is right on, and the sound projects. Lead trumpet players, jazz players, classical performers—each artist can find a model that will suit his style and technique."



**Frank Brodahl** (Norway)  
Norwegian Wind Ensemble.

"Xeno Trumpets blend very well with brass and orchestra ensembles and carry the sound to the last row of chairs. I love it."



**Till Brönner** (Germany)  
International Jazz Soloist.

"I'm glad to have a trumpet that I really adore. This instrument expresses everything that I would like to say."



**Antoine Curé** (France)  
Professor at the National Conservatoire Superior of Paris and a World-Renowned Soloist.

"I chose Yamaha trumpets for their evenness, ease of play and tonal flexibility. And I find these qualities throughout the entire lineup."



**Frits Damrow** (Netherlands)  
Former Principal, Royal Concertgebouw Orchestra Amsterdam Professor of Trumpet, Zurich University of Arts, Switzerland.

"I play on Yamaha trumpets because I feel very comfortable on these instruments. They give me everything I can expect from a top-class trumpet: great sound, good intonation, flexibility and easy of playing."



**Pierre Dutot** (France)  
International Soloist.

"It's always a big pleasure to play on my new Xeno trumpet. It gives me what I want in terms of sound, response and intonation in all settings—whether in an orchestra, brass ensemble or as a soloist."



**Wim Van Hasselt** (Netherlands)  
Soloist, Concertgebouw Orchestra Amsterdam.

"Through its variety of tonal colours Yamaha Trumpets give me the opportunity to realise my musical ideas easily."



**John Hagstrom** (US)  
Member of the Chicago Symphony and an Outstanding Soloist.

"The new Xeno C trumpet is the only available orchestral trumpet that allows a player to achieve any sound they can imagine while still having the potential to be compatible with every sound in the orchestra. Yamaha is the only company in the world that can make these instruments available to everyone at the highest level of quality."



**Sachio Hotokezaka** (Japan)  
Member of the NHK Symphony Orchestra and Member of the Custom Brass Quintet.

"The brilliant sound and soft tonal colors produced by Yamaha trumpets are ideal for all of my performances, from orchestral playing to solos. I will never be separated from this instrument."



**David King** (UK)  
Professor of Performance at the University of Salford; International Conductor and Cornet Soloist.

"How do I say everything about the best cornet in the world in just one sentence? Yamaha's Xeno cornet combines old-school quality with new-age precision. Its hallmarks—projection, power and personality."



**Romain Leleu** (France)  
International Soloist.

"For my solo performances, I have to react quickly to share musical idea when I work with a conductor, or with chamber music partners. My Yamaha trumpet is able to respond to all questions and requests. Sound, Intonation, Flexibility, Easiness of playing high-tone range and Efficiency of my Yamaha trumpets are very high level. So, I'm really happy to play these high quality instruments."

Photos: Caroline Doutré



**Jens Lindemann** (US)  
Active International Soloist and Former First Trumpet with the Canadian Brass.

"Yamaha Xeno trumpets have always allowed me to play in a variety of styles with the greatest of ease due to their incredibly well-centered feel. The sound is rich with incredible projection and easily fills the largest concert halls in the world due to its focus. I have played them my entire career because I trust them ... simple!"



**Brian Lynch** (US)  
Highly Sought-After Jazz Artist, Particularly in Bebop and Latin Groups.

"I've finally found an instrument that gives me everything I need! The horn never lets me down, no matter how demanding the musical context or how much I want to put into my improvised line. Thank you, Yamaha, for helping me to keep searching and extending my playing."



**Manu Mellaerts** (Belgium)

Solo Trumpet with the National Opera "La Monnaie" Brussels and Professor at the Royal Conservatorium Brussels.

"The Yamaha Chicago trumpet models have a full, powerful sound and great projection. They are flexible in all kind of musical styles. I'm glad to play these fantastic trumpets."



**Eric Miyashiro** (Japan)

Lead Player in a Who's Who of Top Bands and Founder of EM Big Band.

"Yamaha trumpets are well designed and manufactured, but the main reason I play them is because they make my job easier. In studios, concert halls, clubs, wherever the gig, my Yamaha lets me concentrate on making music, and I don't have to worry about anything else."



**Tiger Okoshi** (US)

Jazz Trumpeter and Professor at the Berklee College of Music in Boston.

"When I'm playing my horn on the stage, all I want to do is paint the air with my colorful sound. It's fun thinking about, 'How can I?' and 'How should I?' The choices between long and short strokes, quick or slow, high in the canvas or low, bright color or dark, with fat brush or skinny pen ... the fact is, I make up my mind and play them before I know it. I paint with one note at a time. ... Only some instruments can let musicians be in a true world of art."



**Marco Pierobon** (Italy)

International Soloist and Member of the Gornalan Brass Quintet.

"With all my Yamaha instruments I'm really able to choose the sound colour I need depending on the musical situation and style. It is so easy to go from the most symphonic to the extreme lead sound on the same horn. They are simply perfect amplifiers of the sound that I have in my head!"



**Bobby Shew** (US)

Jazz Trumpeter Renowned for Powerful Lead Playing and Expressive Solos.

"I have been fortunate to be allowed to work alongside Yamaha designers in order to create the Z Series of trumpets and flugelhorns. They suit me beautifully for both lead and jazz playing. Thank you, Yamaha!!!"



**Giuliano Sommerhalder** (Netherlands)

International Soloist.

"I have been playing the Yamaha Xeno Chicago C trumpet as well as the Yamaha E/E flat trumpet for half a decade and not only have I been loving the great craftsmanship behind the instruments and their excellent response and intonation, but also the extreme versatility of these instruments. I use the Xeno C trumpet for both orchestral playing and solo/chamber music appearances and this instrument allows me to produce the sound I want in any of these situations."



**Robert Sullivan** (US)

Principal Trumpet, Cincinnati Symphony and Pops Orchestras and a Gifted soloist.

"I have been playing Yamaha trumpets for more than 10 years because they are the best trumpets I have played, and they get better all the time. The response, intonation, flexibility and warmth of sound are exactly what I want from a trumpet, whether I am performing in the orchestra, chamber ensemble or recording studio."



**James Thompson** (US)

Soloist and Trumpet Professor at the Eastman School of Music; Former Principal Trumpet of the Atlanta and Montreal Symphony Orchestras.

"I play Yamaha because the instruments give me what I want in terms of sound, response and intonation. They are the highest quality in terms of manufacturing and consistency."



**Andrea Tofanelli** (Italy)

International Jazz Soloist.

"Regarding the Xeno Europe Trumpet, you cannot think to play without it. It is the ideal horn for players who want to make a difference."



**Allen Vizzutti** (US)

Soloist in a Multitude of Musical Genres—From Jazz to Classical.

"I have used the complete line of Yamaha trumpets for 20 years. I play them for one reason and one reason only: because they are fantastic. In my musical life, I face a multitude of challenges in a myriad of musical settings. My Yamaha trumpets always help me meet the demands of the professional music world. Their workmanship, quality, consistency and beauty of sound are world-class."

## Play Whenever You Want, Wherever You Want!



The innovative SILENT BRASS™ allows you to practice in your own private musical world.

SB7-9 set includes a PM7 Pickup Mute™ and ST7 Personal Studio™ with earphones, so you can listen to yourself play at a normal volume while others hear only a whisper.

**PM6**  
for Flugelhorn and Alto Trombone



**PM9**  
for Piccolo Trumpet

**PM7**  
for Trumpet and Cornet



**ST9**

## Get to Know the Basic Trumpet Parts

### 1 Mouthpiece

Here's where the sound starts! The mouthpiece transfers vibrations from your lips into the horn. Mouthpieces are made with a variety of options including rim width and shape, cup volume, bore sizes and material. Your choices have a significant influence on the sound and ease in blowing. Selecting a mouthpiece is a very complicated subject, so we suggest you choose a standard size if you're just starting out.

### 2 Mouthpiece Receiver 3 Leadpipe

The mouthpiece connects to the trumpet at the receiver. The shape of the leadpipe can vary, changing airflow.

### 4 Piston Valves 5 Finger Hook

Most trumpets have three piston valves that produce notes when pressed in various combinations with the fingers on your right hand. The pinky finger hook helps you hold the instrument and free your left hand. Apply valve oil before and after playing to avoid wear, deterioration and rust.

### 6 First Tuning Slide 8 Second Tuning Slide 10 Third Tuning Slide

These pipes that can be pulled or pushed to finely adjust the pitch.

### 7 First Tuning Slide Finger Hook 9 Third Tuning Slide Finger Ring

These finger hooks allow you to hold and steady the instrument while you are playing and while adjusting the pitch with the tuning slides. The basic technique is to hook your thumb on the first tuning slide finger hook and the third finger on the third tuning slide finger ring. Some hooks have a closed ring shape and some have an open "U" shape.

### 11 Brace

Some models have no brace at all while others have one or two. More braces result in a more solid and unified sound.

### 12 Main Tuning Slide 13 Water Key

This primary tuning slide provides the most adjustment in pitch. The water key releases condensation that builds up inside the horn while you play.

### 14 Bell

The music exits the trumpet through the bell. The actual sound—it's timbre and other characteristics—depends on the size, shape and material of the bell as well as the shape of the trim.

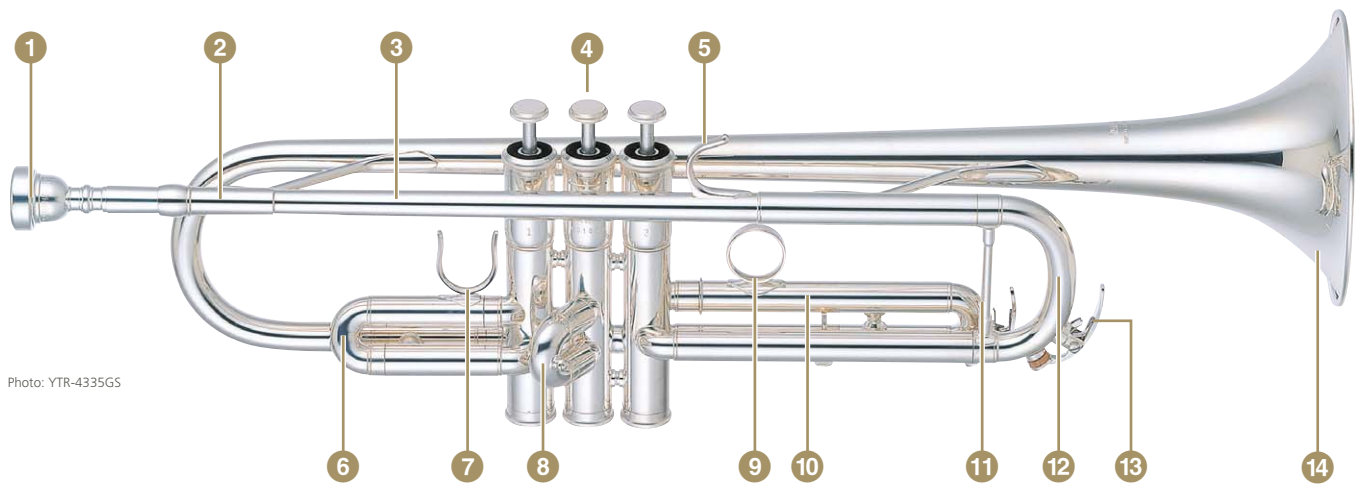

Photo: YTR-4335GS

## Other Tips for Choosing a Trumpet

### Material and Finish

Brass instruments produce different sounds and tone colors depending on the material and surface finish. Decide what kind of sound you like best, then find an instrument whose material and finish would best produce that sound. Generally, silver plating is most common; however, many jazz musicians prefer a lacquer finish.

#### • Bell Material

**Yellow brass:** Bright and energetic sound

**Gold brass:** Rich and wide sound

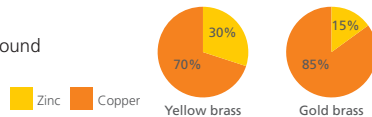

#### • Finish

**Lacquer Finish:** Solid and relatively dark sound, particularly good for playing in forte.

**Silver Plated Finish:** Soft and relatively light sound, capable of expressing a wide variety of subtle nuances.

### Brace

The brace affects the appearance as well as the sound and the feeling of playing.

**Without Brace:** Open feeling

**With Brace:** Solid sound

## Scale Range (B $\flat$ )

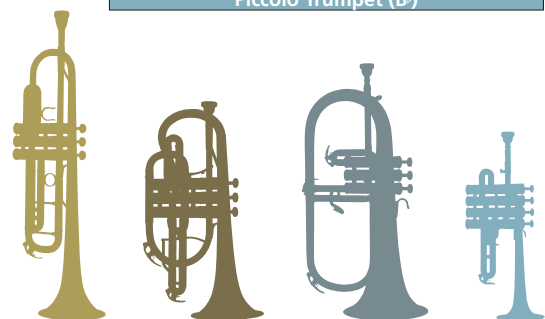
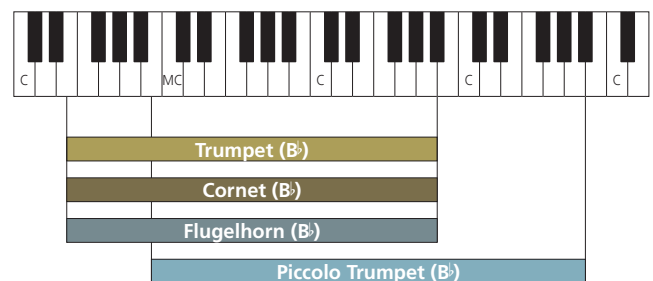



# Specifications

## Trumpets

Key	Grade	Model	Bell	Bell diameter	Bore size	Finish	Mouthpiece	Page		
B <sup>b</sup>	Xeno Artist	<b>YTR-9335CHS*</b>	One piece yellow brass	123 mm (4-7/8")	ML 11.65 mm (0.459")	Silver plate	TR17B4	04		
		<b>YTR-9335NYS*</b>	One piece yellow brass	123 mm (4-7/8")	ML 11.65 mm (0.459")	Silver plate	TR17B4	05		
	Custom Xeno	<b>YTR-8335</b>	One piece yellow brass	123 mm (4-7/8")	ML 11.65 mm (0.459")	ML 11.65 mm (0.459")	Clear lacquer	TR16C4-GP	06	
		<b>YTR-8335S</b>	One piece yellow brass	123 mm (4-7/8")	ML 11.65 mm (0.459")	ML 11.65 mm (0.459")	Silver plate	TR16C4-GP	06	
		<b>YTR-8335G</b>	One piece gold brass	123 mm (4-7/8")	ML 11.65 mm (0.459")	ML 11.65 mm (0.459")	Clear lacquer	TR16C4-GP	06	
		<b>YTR-8335GS</b>	One piece gold brass	123 mm (4-7/8")	ML 11.65 mm (0.459")	ML 11.65 mm (0.459")	Silver plate	TR16C4-GP	06	
		<b>YTR-8345</b>	One piece yellow brass	123 mm (4-7/8")	L 11.73 mm (0.462")	L 11.73 mm (0.462")	Clear lacquer	TR16C4-GP	06	
		<b>YTR-8345S</b>	One piece yellow brass	123 mm (4-7/8")	L 11.73 mm (0.462")	L 11.73 mm (0.462")	Silver plate	TR16C4-GP	06	
		<b>YTR-8345G</b>	One piece gold brass	123 mm (4-7/8")	L 11.73 mm (0.462")	L 11.73 mm (0.462")	Clear lacquer	TR16C4-GP	06	
		<b>YTR-8345GS</b>	One piece gold brass	123 mm (4-7/8")	L 11.73 mm (0.462")	L 11.73 mm (0.462")	Silver plate	TR16C4-GP	06	
	Custom	<b>YTR-8335RGS</b>	One piece gold brass	123 mm (4-7/8")	ML 11.65 mm (0.459")	ML 11.65 mm (0.459")	Silver plate	TR16C4-GP	07	
		<b>YTR-8335LA</b>	One piece yellow brass	127 mm (5")	ML 11.65 mm (0.459")	ML 11.65 mm (0.459")	Gold lacquer	TR14B4	08	
		<b>YTR-8335LAS</b>	One piece yellow brass	127 mm (5")	ML 11.65 mm (0.459")	ML 11.65 mm (0.459")	Silver plate	TR14B4	08	
		<b>YTR-8340EM</b>	One piece yellow brass	134.4 mm (5-1/4")	Multi-bore	Multi-bore	Gold lacquer	EM1	08	
		<b>YTR-8310Z</b>	One piece yellow brass	127 mm (5")	Step bore 11.3 mm (0.445")	Step bore 11.3 mm (0.445")	Gold lacquer	SHEW-JAZZ	09	
		<b>YTR-8310ZS</b>	One piece yellow brass	127 mm (5")	Step bore 11.3 mm (0.445")	Step bore 11.3 mm (0.445")	Silver plate	SHEW-JAZZ	09	
		<b>YTR-938FFMS*</b>	One piece yellow brass	138mm (5-7/16")	M 11.24 mm (0.442")	M 11.24 mm (0.442")	Silver plate	TR16E4	18	
		<b>YTR-938FFMGS*</b>	One piece gold brass	138mm (5-7/16")	M 11.24 mm (0.442")	M 11.24 mm (0.442")	Silver plate	TR16E4	18	
		Professional	<b>YTR-6335</b>	One piece yellow brass	123 mm (4-7/8")	ML 11.65 mm (0.459")	ML 11.65 mm (0.459")	Gold lacquer	TR14B4	10
			<b>YTR-6335S</b>	One piece yellow brass	123 mm (4-7/8")	ML 11.65 mm (0.459")	ML 11.65 mm (0.459")	Silver plate	TR14B4	10
<b>YTR-6345G</b>	One piece gold brass		123 mm (4-7/8")	L 11.73 mm (0.462")	L 11.73 mm (0.462")	Gold lacquer	TR14B4	10		
<b>YTR-6345GS</b>	One piece gold brass		123 mm (4-7/8")	L 11.73 mm (0.462")	L 11.73 mm (0.462")	Silver plate	TR14B4	10		
<b>YTR-6330F</b>	Two piece yellow brass		123 mm (4-7/8")	ML 11.65 mm (0.459")	ML 11.65 mm (0.459")	Clear lacquer	TR14B4	17		
Intermediate	<b>YTR-4335GII</b>	Two piece gold brass	123 mm (4-7/8")	ML 11.65 mm (0.459")	ML 11.65 mm (0.459")	Gold lacquer	TR11B4	11		
	<b>YTR-4335GSII</b>	Two piece gold brass	123 mm (4-7/8")	ML 11.65 mm (0.459")	ML 11.65 mm (0.459")	Silver plate	TR11B4	11		
Student	<b>YTR-3335</b>	Two piece yellow brass	123 mm (4-7/8")	ML 11.65 mm (0.459")	ML 11.65 mm (0.459")	Gold lacquer	TR11B4	12		
	<b>YTR-3335S</b>	Two piece yellow brass	123 mm (4-7/8")	ML 11.65 mm (0.459")	ML 11.65 mm (0.459")	Silver plate	TR11B4	12		
	<b>YTR-2330</b>	Two piece yellow brass	123 mm (4-7/8")	ML 11.65 mm (0.459")	ML 11.65 mm (0.459")	Gold lacquer	TR11B4	13		
	<b>YTR-2330S</b>	Two piece yellow brass	123 mm (4-7/8")	ML 11.65 mm (0.459")	ML 11.65 mm (0.459")	Silver plate	TR11B4	13		
C	Xeno Artist	<b>YTR-9445CHS*</b>	One piece yellow brass	123 mm (4-7/8")	L 11.73 mm (0.462")	Silver plate	TR17B4	04		
		<b>YTR-9445NYS*</b>	One piece yellow brass	123 mm (4-7/8")	L 11.73 mm (0.462")	Silver plate	TR17B4	05		
	Custom Xeno	<b>YTR-8445</b>	One piece yellow brass	123 mm (4-7/8")	L 11.73 mm (0.462")	L 11.73 mm (0.462")	Clear lacquer	TR16C4-GP	07	
		<b>YTR-8445S</b>	One piece yellow brass	123 mm (4-7/8")	L 11.73 mm (0.462")	L 11.73 mm (0.462")	Silver plate	TR16C4-GP	07	
		<b>YTR-8445G</b>	One piece gold brass	123 mm (4-7/8")	L 11.73 mm (0.462")	L 11.73 mm (0.462")	Clear lacquer	TR16C4-GP	07	
		<b>YTR-8445GS</b>	One piece gold brass	123 mm (4-7/8")	L 11.73 mm (0.462")	L 11.73 mm (0.462")	Silver plate	TR16C4-GP	07	
	Custom	<b>YTR-948FFMS*</b>	One piece yellow brass	130 mm (5-7/16")	M 11.24 mm (0.442")	M 11.24 mm (0.442")	Silver plate	TR16E4	18	
		<b>YTR-948FFMGS*</b>	One piece gold brass	130 mm (5-7/16")	M 11.24 mm (0.442")	M 11.24 mm (0.442")	Silver plate	TR16E4	18	
C-B <sup>b</sup>	Intermediate	<b>YTR-4435II</b>	Two piece yellow brass	123 mm (4-7/8")	ML 11.65 mm (0.459")	Gold lacquer	TR11B4	11		
		<b>YTR-4435SII</b>	Two piece yellow brass	123 mm (4-7/8")	ML 11.65 mm (0.459")	Silver plate	TR11B4	11		
E <sup>b</sup>	Custom	<b>YTR-9630*</b>	One piece gold brass	127 mm (5")	M 11.3 mm (0.445")	Silver plate	TR14B4	16		
E-E <sup>b</sup>	Custom	<b>YTR-9635*</b>	One piece yellow brass	123 mm (4-7/8")	ML 11.65 mm (0.459")	Silver plate	TR14B4	16		
E <sup>b</sup> -D	Custom	<b>YTR-9636*</b>	One piece yellow brass	123 mm (4-7/8")	ML 11.65 mm (0.459")	Silver plate	TR14B4	16		
		<b>YTR-9610*</b>	One piece yellow brass	120 mm (4-3/4")	M 11.3 mm (0.445")	Silver plate	TR14B4	16		
	Professional	<b>YTR-6610S</b>	One piece yellow brass	120 mm (4-3/4")	M 11.3 mm (0.445")	Silver plate	TR14B4	17		
G-F	Custom	<b>YTR-9710*</b>	One piece yellow brass	101 mm (4")/110 mm (4-1/3")	M 11.3 mm (0.445")	Silver plate	TR14A4a	17		

## Piccolo Trumpets

Key	Grade	Model	Bell	Bell diameter	Bore size	Finish	Mouthpiece	Page
B <sup>b</sup> -A	Custom	<b>YTR-988*</b>	One piece yellow brass	97.9mm (3-15/16")	S 10.38 mm (0.409")	Silver plate	TR11A5	15
		<b>YTR-9825*</b>	One piece yellow brass	101 mm (4")	M 11.30 mm (0.445")	Silver plate	TR11A5, CR11A4	15
		<b>YTR-9835*</b>	One piece yellow brass	101 mm (4")	M 11.30 mm (0.445")	Silver plate	TR11A5, CR11A4	15
Professional	<b>YTR-6810</b>	One piece yellow brass	94 mm (3-3/4")	S 10.50 mm (0.413")	S 10.50 mm (0.413")	Gold lacquer	TR14A4a	15
	<b>YTR-6810S</b>	One piece yellow brass	94 mm (3-3/4")	S 10.50 mm (0.413")	S 10.50 mm (0.413")	Silver plate	TR14A4a	15

\* Order model.

• All specifications are subject to change without notice.

# Specifications

## Cornets

Key	Grade	Model	Bell	Bell diameter	Bore size	Finish	Mouthpiece	Page
B <sup>b</sup>	Custom Xeno	<b>YCR-8335</b>	One piece yellow brass	125.5 mm (5")	L 11.9 mm (0.469")	Clear lacquer	KING	20
		<b>YCR-8335S</b>	One piece yellow brass	125.5 mm (5")	L 11.9 mm (0.469")	Silver plate	KING	20
		<b>YCR-8335G</b>	One piece gold brass	125.5 mm (5")	L 11.9 mm (0.469")	Clear lacquer	KING	20
		<b>YCR-8335GS</b>	One piece gold brass	125.5 mm (5")	L 11.9 mm (0.469")	Silver plate	KING	20
	Professional	<b>YCR-6330II</b>	One piece yellow brass	119 mm (4-2/3")	ML 11.73 mm (0.462")	Clear lacquer	CR11E4 (S)	20
		<b>YCR-6330SII</b>	One piece yellow brass	119 mm (4-2/3")	ML 11.73 mm (0.462")	Silver plate	CR11E4 (S)	20
	Intermediate	<b>YCR-4330GII</b>	Two piece gold brass	119 mm (4-2/3")	ML 11.65 mm (0.459")	Gold lacquer	CR11E4 (S)	21
		<b>YCR-4330GSII</b>	Two piece gold brass	119 mm (4-2/3")	ML 11.65 mm (0.459")	Silver plate	CR11E4 (S)	21
	Student	<b>YCR-2330III</b>	Two piece yellow brass	119 mm (4-2/3")	ML 11.65 mm (0.459")	Gold lacquer	CR11E4 (S)	21
		<b>YCR-2330SIII</b>	Two piece yellow brass	119 mm (4-2/3")	ML 11.65 mm (0.459")	Silver plate	CR11E4 (S)	21
		<b>YCR-2310III</b>	Two piece yellow brass	119 mm (4-2/3")	ML 11.65 mm (0.459")	Gold lacquer	CR11C4 (L)	21
		<b>YCR-2310SIII</b>	Two piece yellow brass	119 mm (4-2/3")	ML 11.65 mm (0.459")	Silver plate	CR11C4 (L)	21
C	Custom	<b>YCR-9435*</b>	One piece yellow brass	123 mm (4-7/8")	ML 11.65 mm (0.459")	Silver plate	TR16C4	20
E <sup>b</sup>	Custom Xeno	<b>YCR-8620S</b>	One piece yellow brass	120 mm (4-3/4")	ML 11.3 mm (0.445")	Silver plate	CR6B4 (L)	20
	Student	<b>YCR-2610SIII</b>	Two piece yellow brass	119 mm (4-2/3")	ML 11.65 mm (0.459")	Silver plate	CR7D4d (S)	21

## Flugelhorns

Key	Grade	Model	Bell	Bell diameter	Bore size	Finish	Mouthpiece	Page
B <sup>b</sup>	Custom	<b>YFH-8310Z</b>	One piece yellow brass	151.8 mm (6")	S 10.5 mm (0.413")	Clear lacquer	SHEW-FH	19
		<b>YFH-8310ZS</b>	One piece yellow brass	151.8 mm (6")	S 10.5 mm (0.413")	Silver plate	SHEW-FH	19
		<b>YFH-8310ZG</b>	One piece yellow brass	151.8 mm (6")	S 10.5 mm (0.413")	Clear lacquer	SHEW-FH	19
		<b>YFH-8310ZGS</b>	One piece yellow brass	151.8 mm (6")	S 10.5 mm (0.413")	Silver plate	SHEW-FH	19
		<b>YFH-8315G</b>	Two piece gold brass	151.8 mm (6")	S 10.5 mm (0.413")	Clear lacquer	FH14F4	19
	Professional	<b>YFH-8315GS</b>	Two piece gold brass	151.8 mm (6")	S 10.5 mm (0.413")	Silver plate	FH14F4	19
		<b>YFH-631G</b>	Two piece gold brass	151.8 mm (6")	MS 11 mm (0.433")	Clear lacquer	FH11F4	19
	Student	<b>YFH-631GS</b>	Two piece gold brass	151.8 mm (6")	MS 11 mm (0.433")	Silver plate	FH11F4	19
		<b>YFH-2310</b>	Two piece yellow brass	151.8 mm (6")	M 11.3 mm (0.445")	Clear lacquer	FH11F4	19
		<b>YFH-2310S</b>	Two piece yellow brass	151.8 mm (6")	M 11.3 mm (0.445")	Silver plate	FH11F4	19

\* Order model.

• All specifications are subject to change without notice.



CREATING 'KANDO' TOGETHER